

STEINBERG



Waschtisch-Einhebelmischbatterie

Art.Nr.160 1814

Installation

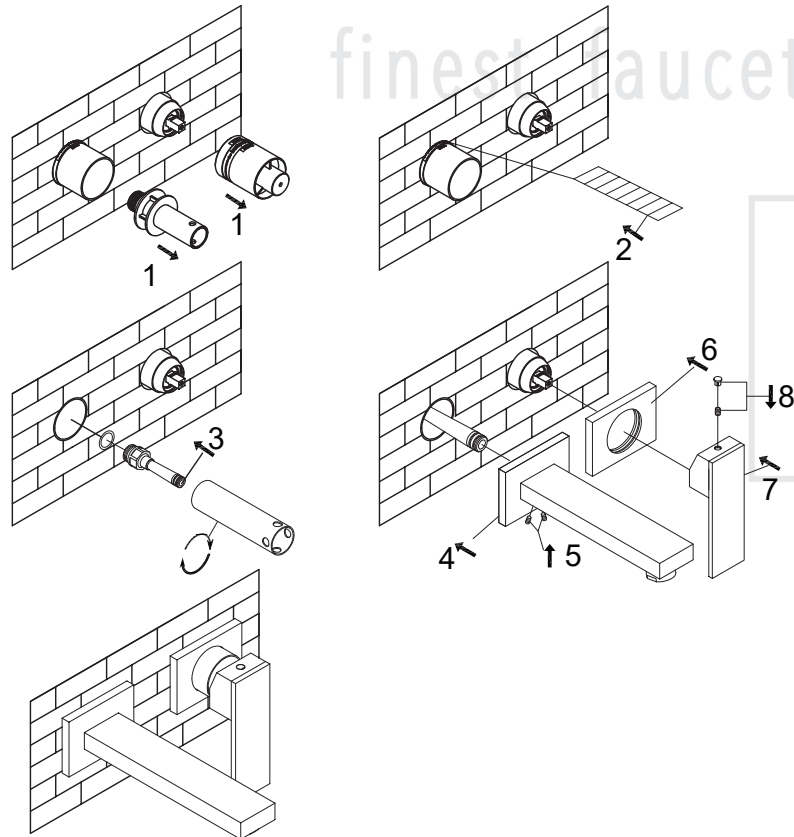
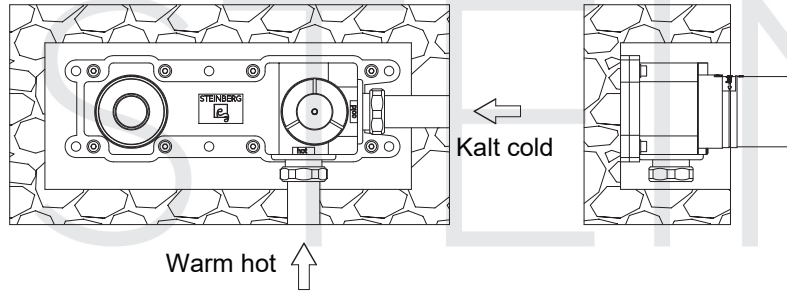

Technische Zeichnung

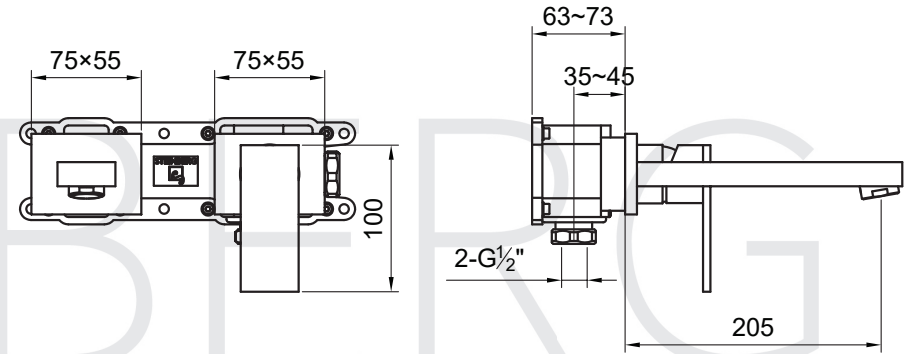

Explosionszeichnung

