

PanELe Abdichtung / Sealing System

Montageanleitung

Installation instructions

Instruction de montage

Istruzione di montaggio

Instrucciones de montaje

Montážní návod

Montagevoorschrift

Instrukcja montażu

Monteringsanvisning

Инструкция по монтажу

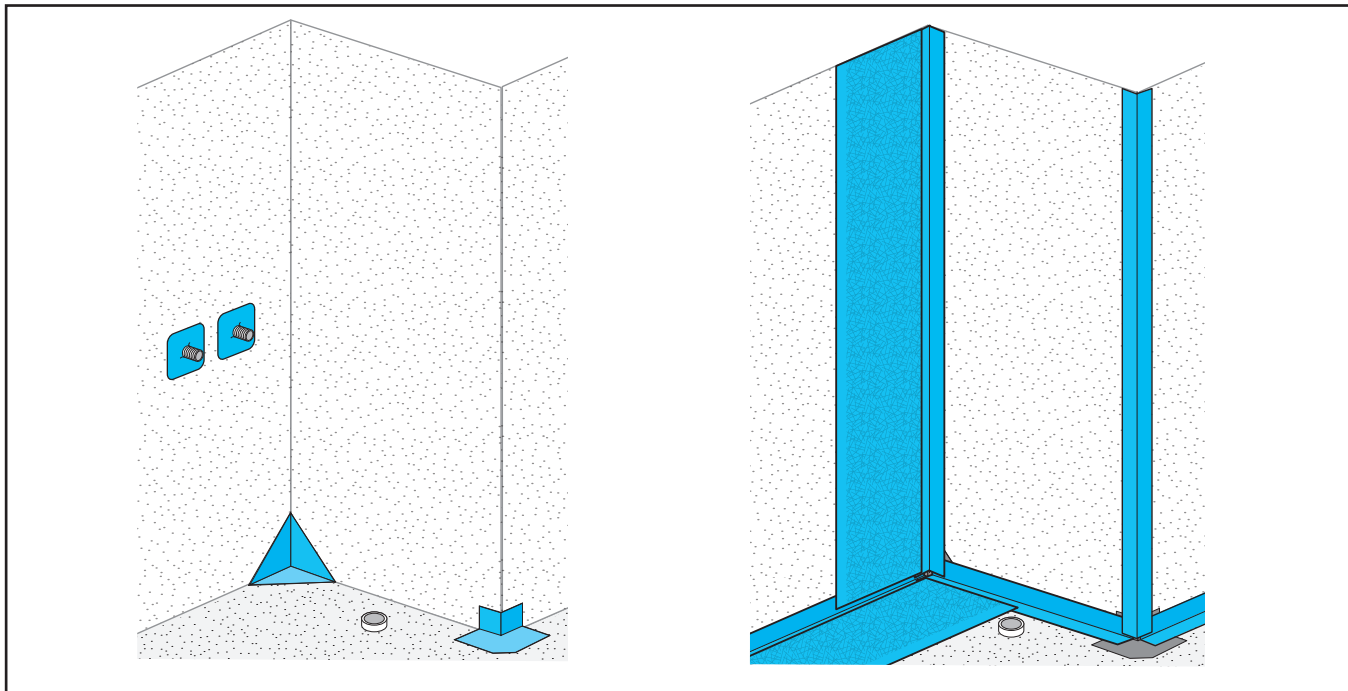

(D) Achtung!

Montageanleitung für den Fachhandwerker! Montageanleitung nach erfolgter Montage dem Endkunden übergeben. Vor Montage Produkt auf Schäden und Vollständigkeit prüfen. Schäden durch Montage erkennbar unvollständig oder mangelhafter Produkte können nicht übernommen werden.

(GB) Warning!

Assembly instructions for skilled tradesmen! Pass the installation instructions on to the customer after assembly. Before assembly, check the product for damage and completeness. Damage caused by assembling products that are recognisably incomplete or faulty will not be accepted.

(F) Attention!

Notice de montage pour l'artisan spécialisé! Remettre cette notice de montage au client final une fois le montage effectué. Avant le montage, vérifier que le produit est complet et en bon état. Les dégâts causés par le montage ou les produits défectueux ne pourront pas être repris une fois montés.

(I) Attenzione!

Istruzioni di assemblaggio per esercenti specializzati! Dopo l'assemblaggio, inoltrare le relative istruzioni al cliente. Prima di eseguire il montaggio verificare le condizioni dell'articolo e accertare la presenza di eventuali danni. Gli articoli che presentano danni conseguenti al montaggio, difettosi o incompleti non potranno essere restituiti.

(E) Atención!

Manual de montaje para el trabajador especializado! Devolución del manual al cliente tras el montaje. Antes del montaje del producto comprobar si está completo y no presenta daños. No nos podemos hacer responsables de los daños producidos por el montaje de productos obviamente defectuosos o incompletos.

(CZ) (SK) Pozor!

Montážní návod pro kvalifikované řemeslníky! Po montáži, předejte montážní návod zákazníkovi. Před montáží zkontrolujte, zda výrobek není poškozen a zda je kompletní. Škody způsobené montáží výrobku, který je vadný nebo neúplný nebudou přijaty.

(NL) Attentie!

Montagehandleiding voor de installateur! Na de installatie deze montagehandleiding aan de klant geven. Hierin staan de bestelnummers voor reserveonderdelen. Voor de montage het product zorgvuldig controleren en eventuele tekortkomingen direct aan de leverancier melden. In geval van schade dient de verpakking bewaard te blijven. Voor schades aan reeds gemonteerde producten wordt geen verantwoordelijkheid aanvaard!

(PL) Uwaga!

Instrukcja montażu dla instalatora! Po zamontowaniu instrukcję montażu proszę przekazać klientowi końcowemu. Przed montażem produkt musi być sprawdzony pod względem uszkodzeń. Uszkodzenia zgłoszone po zamontowaniu produktu nie mogą być podstawą reklamacji.

(N) Viktig!

Monteringsanvisning for installatør. Gi monteringsanvisningen til forbrukeren. Kontroller at dusjveggen ikke er transportskadet før montering, da det etter montering ikke kan reklameres på slike skader.

(RUS) Внимание!

Инструкция по монтажу. После монтажа вернуть клиенту! Перед монтажом проверить продукцию на наличие брака и комплектность изделия. Повреждения при монтаже не рассматриваются как рекламация.

Benötigtes Werkzeug
Necessary tools
Outil Nécessaire
Attrezzature necessaria
Herramientas necesarias

Potřebné nářadí
Gereedschap
Niezbędne narzędzia
Nødvendig verktøy
Инструменты для монтажа

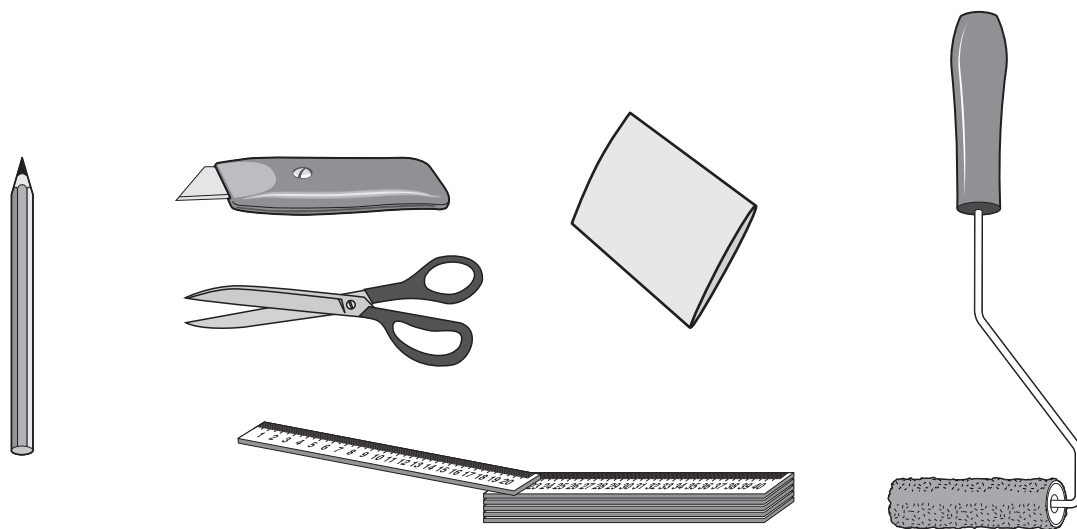

Produkte
Products
Produits
Prodotti
Productos

Produkty
Producten
Produkty
Produkter
продукты

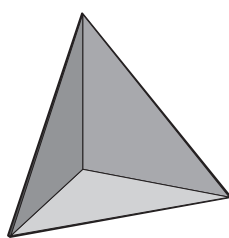

621899

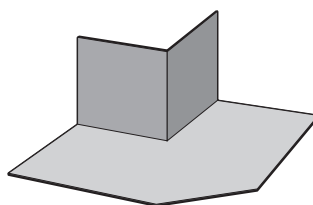

621900

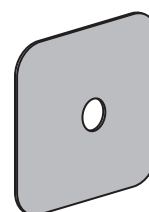

621901

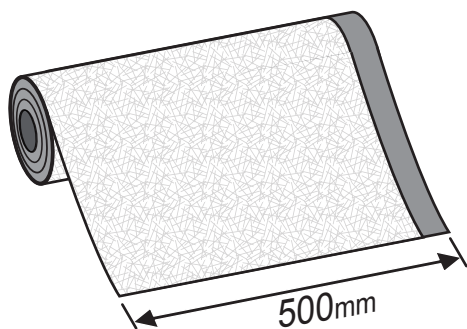

752391

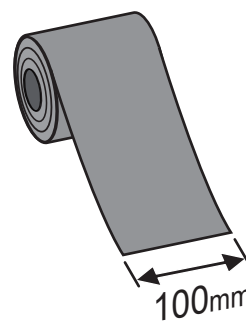

621898

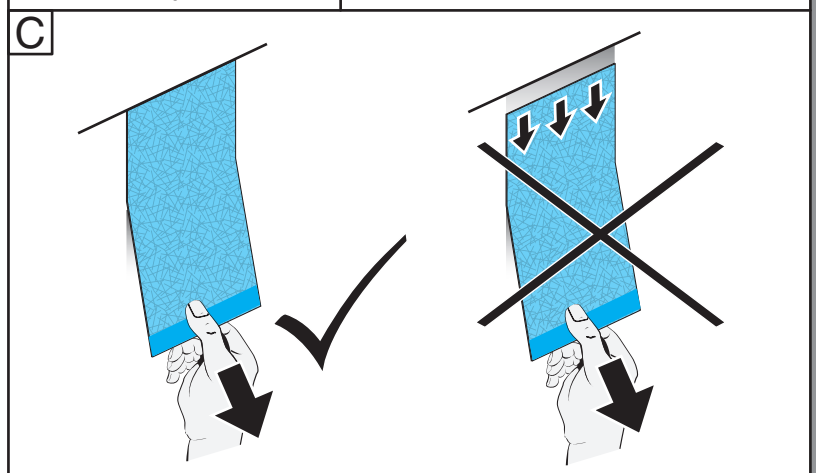
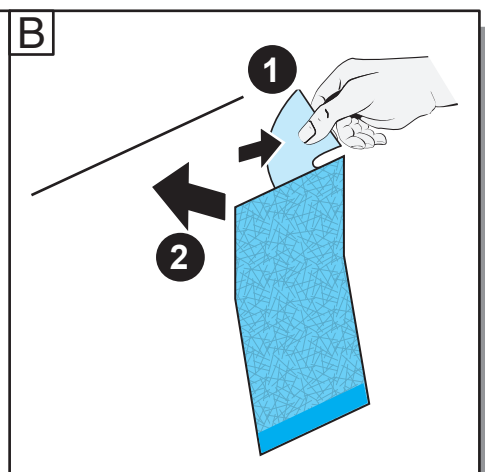
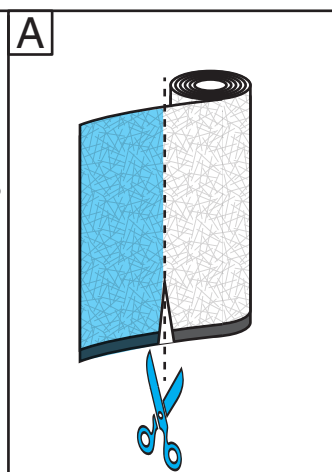
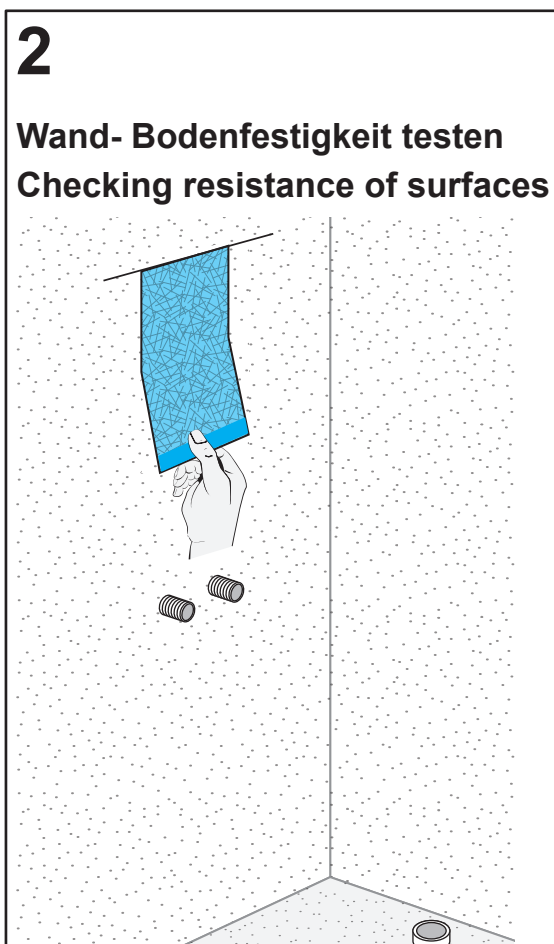
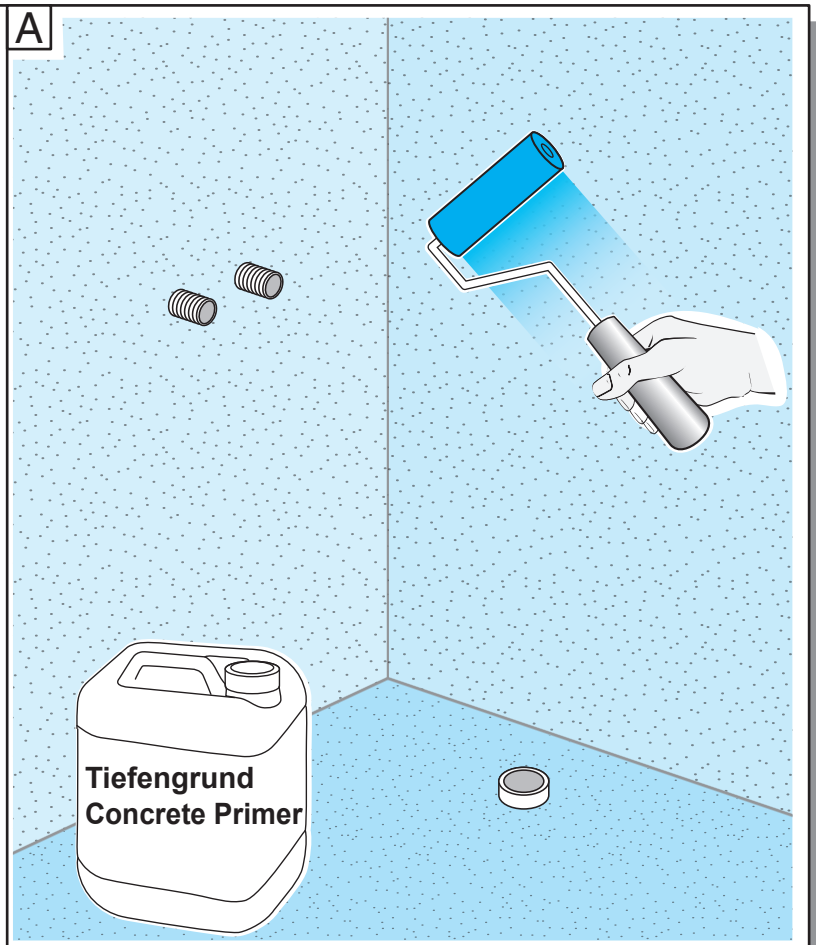
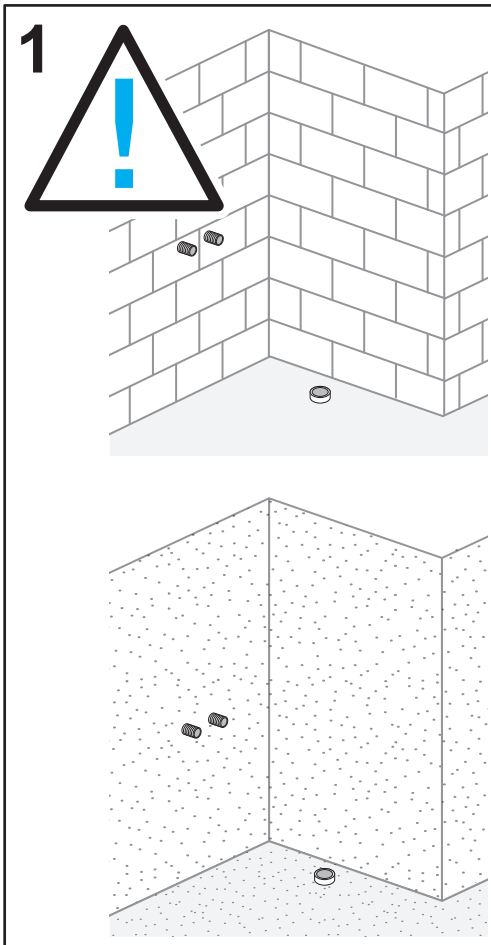

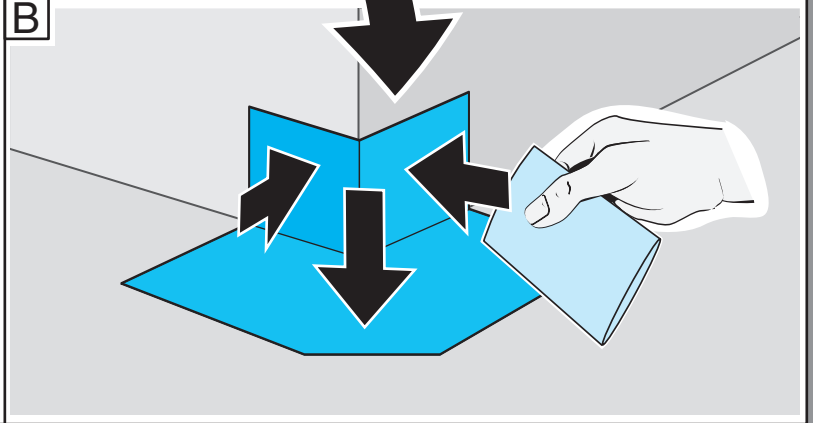
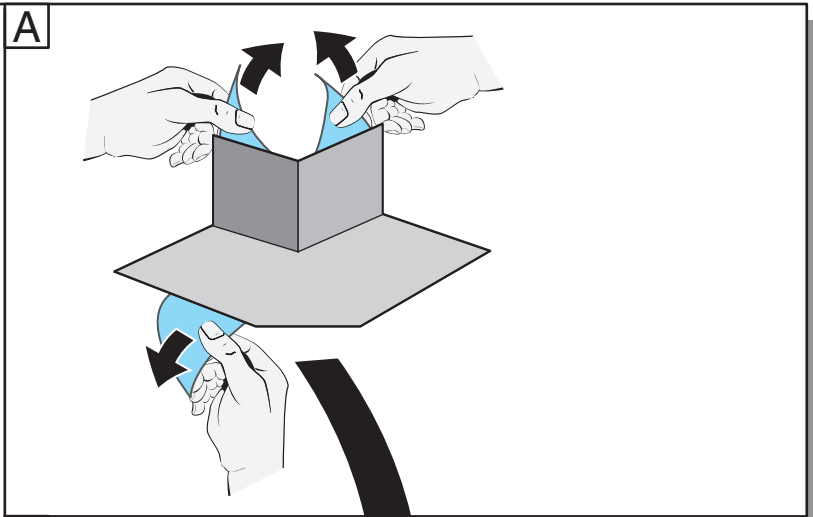
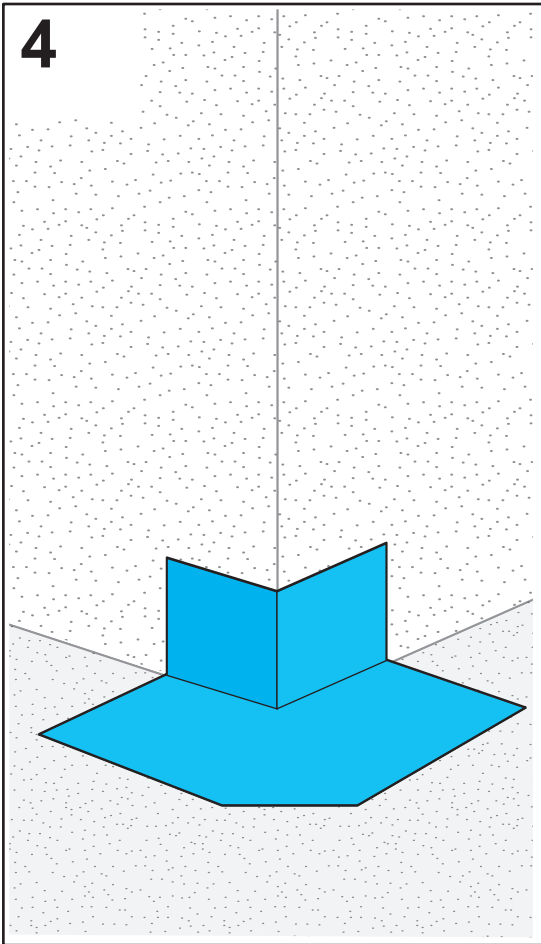
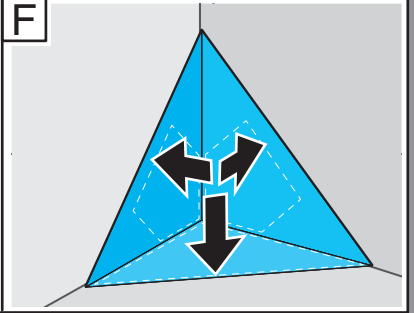
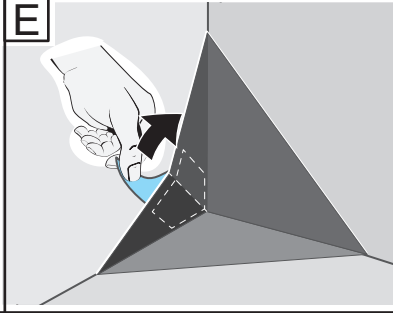
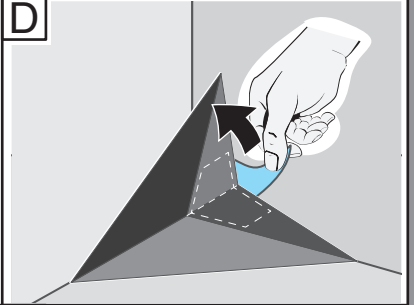
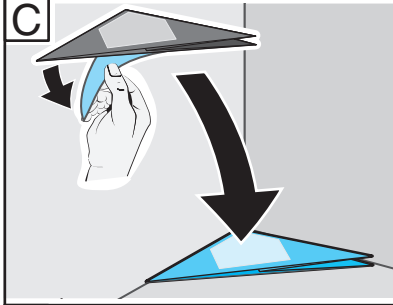
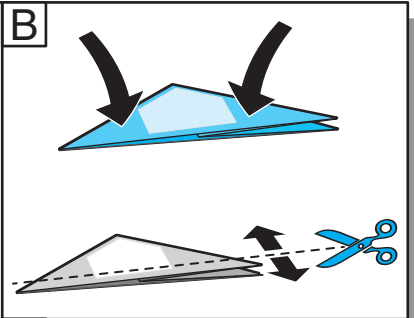
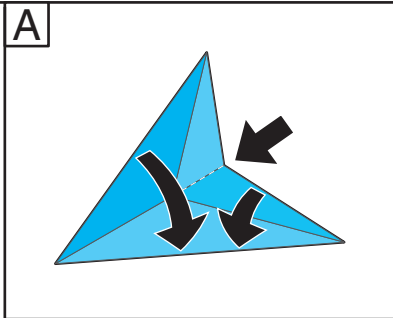
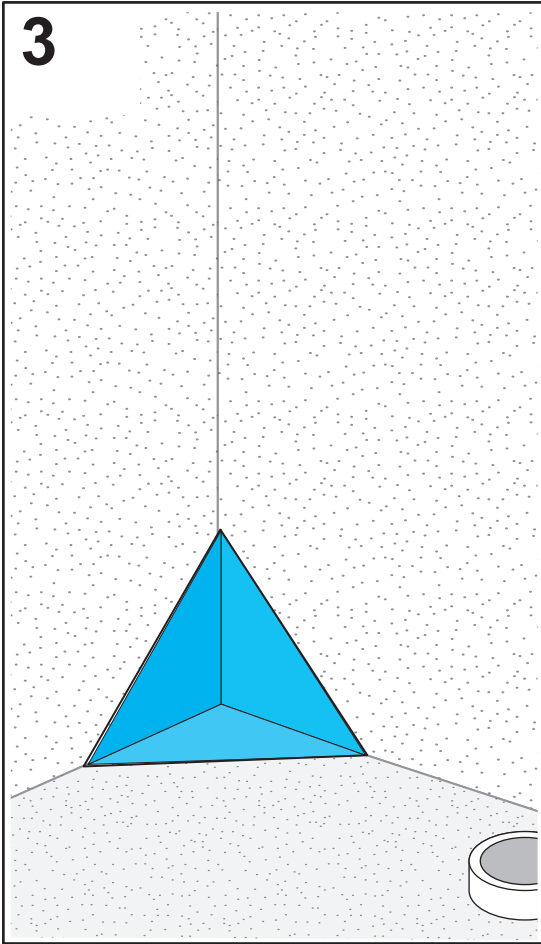

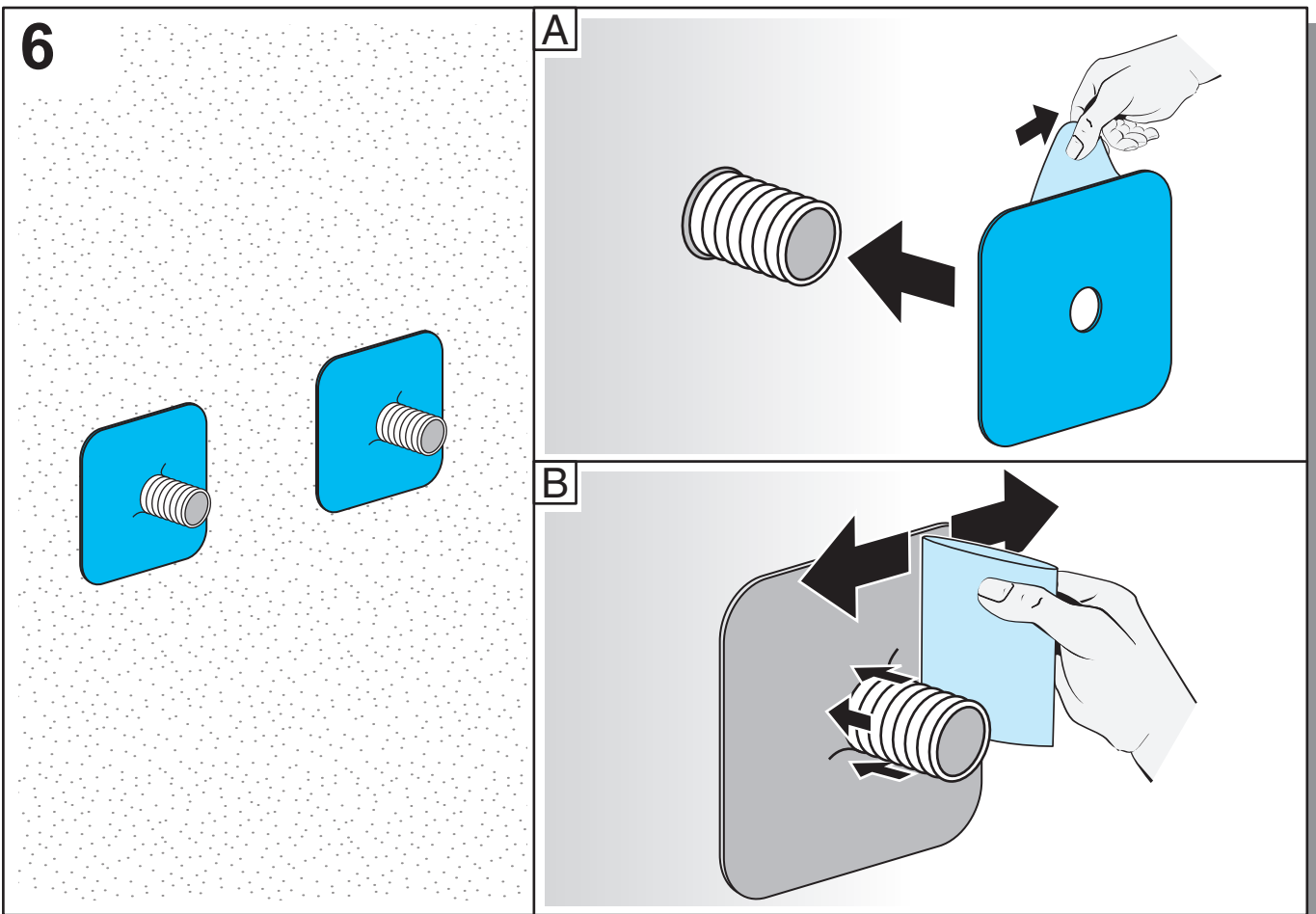
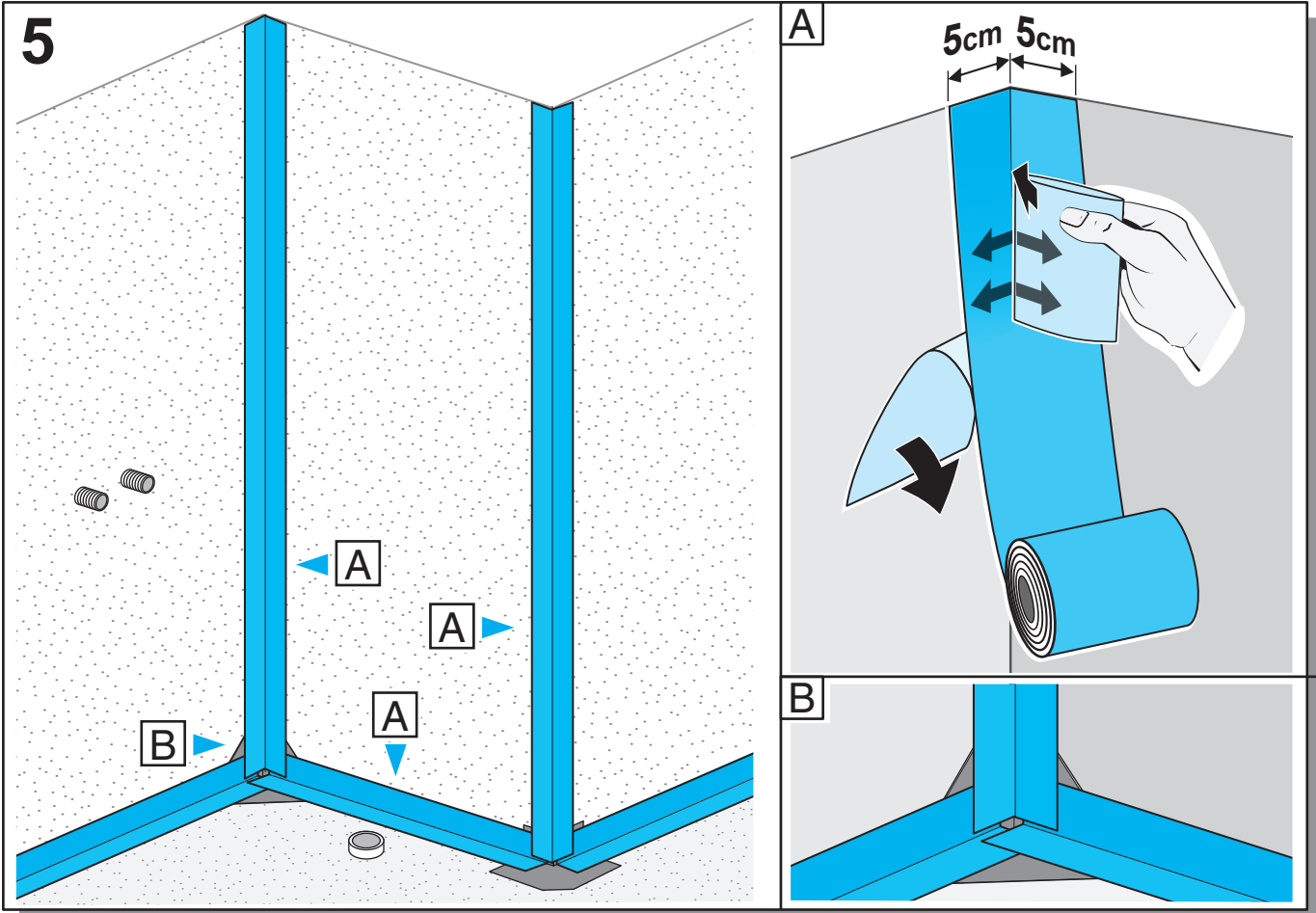

7

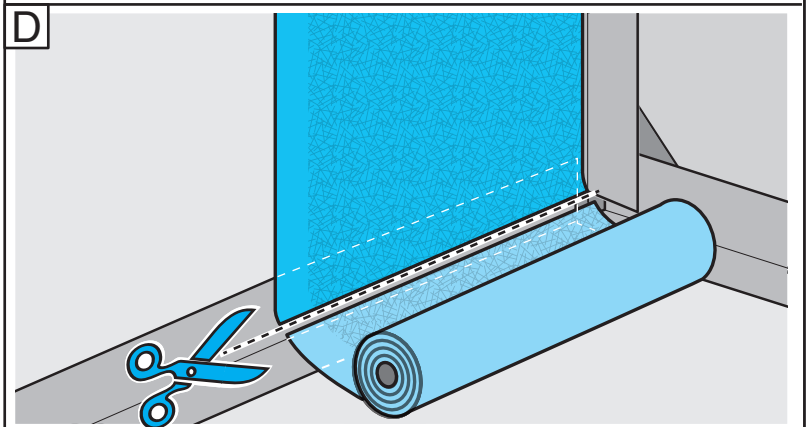
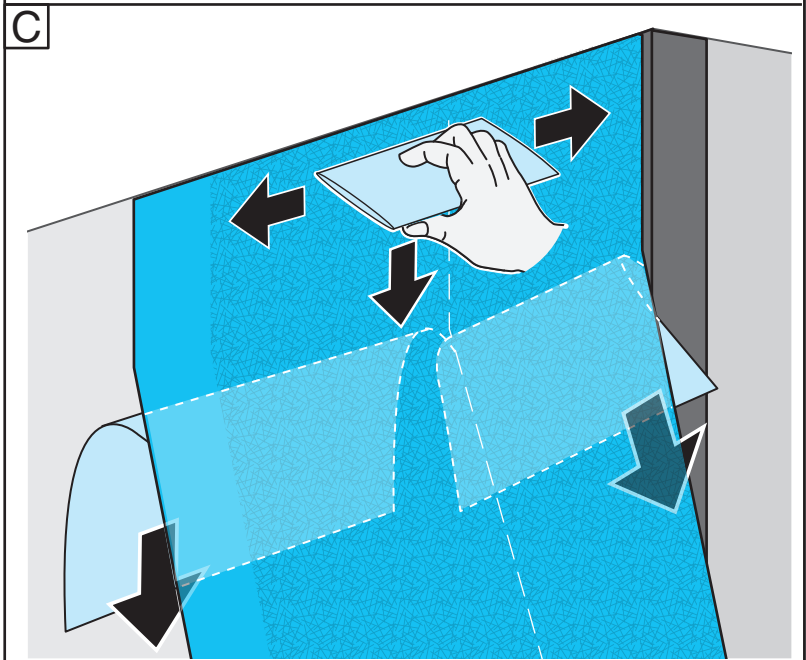
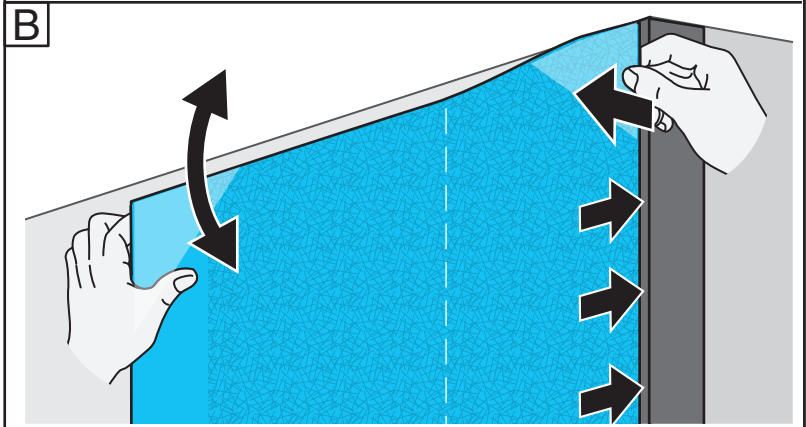
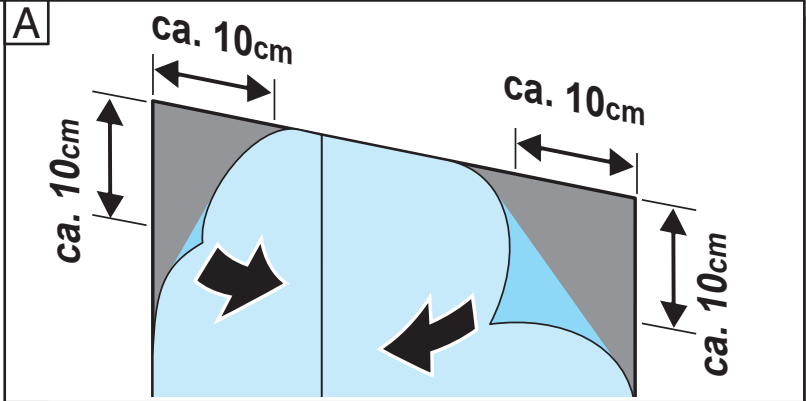
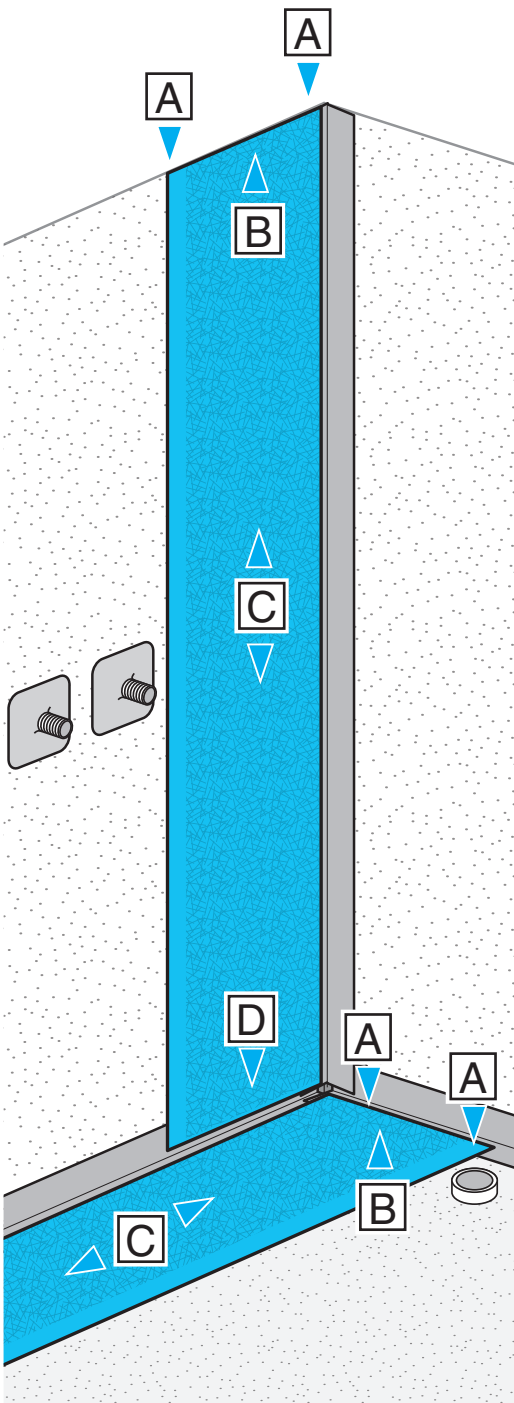

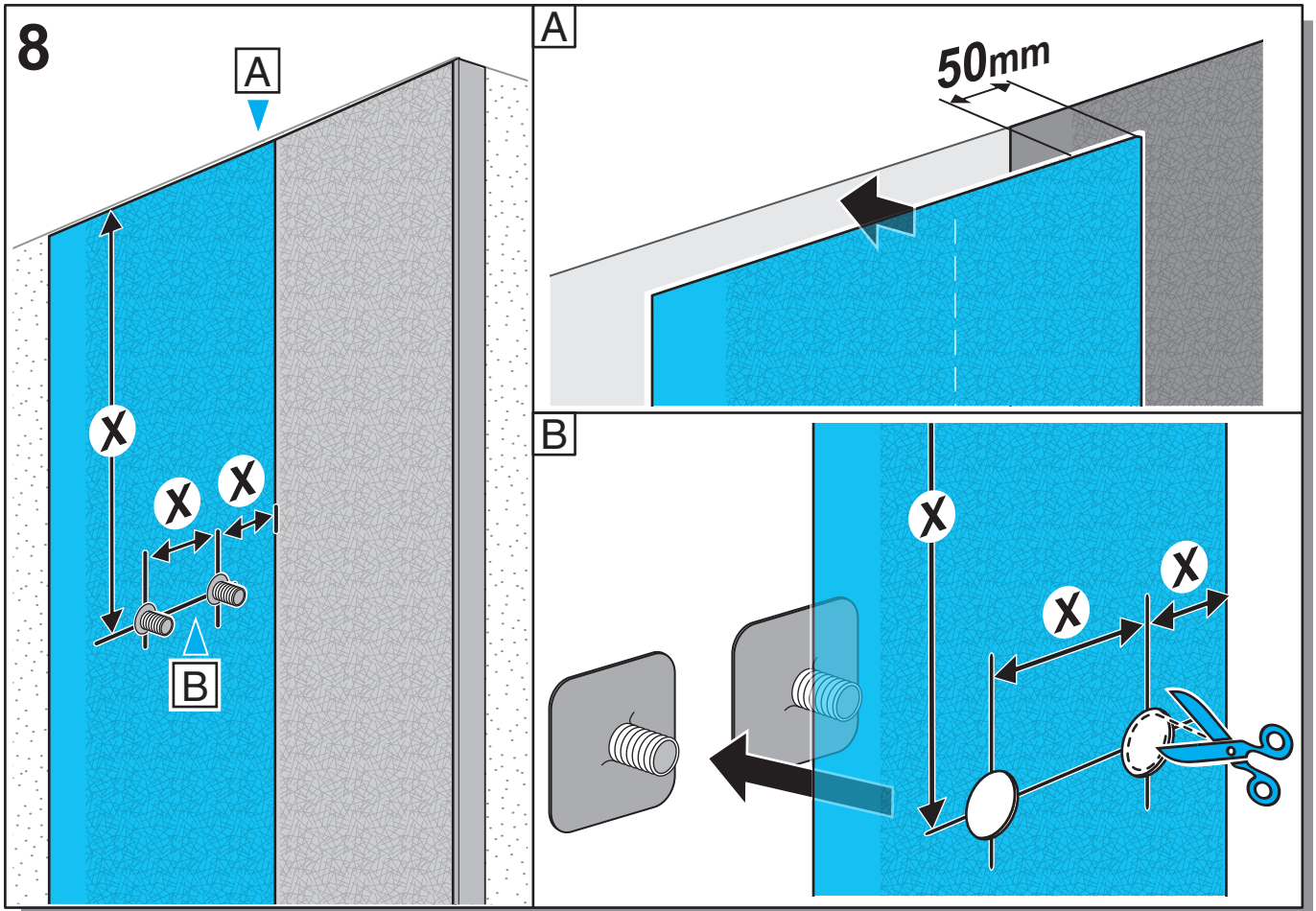

PanEile Abdichtung / Sealing System

